

Deutsches Institut für Bautechnik

Anstalt des öffentlichen Rechts

Kolonnenstr. 30 B
10829 Berlin
Germany

Tel.: +49(0)30 787 30 0
Fax: +49(0)30 787 30 320
E-mail: dibt@dibt.de
Internet: www.dibt.de



DIBt

Mitglied der EOTA
Member of EOTA

European Technical Approval ETA-05/0231

English translation prepared by DIBt - Original version in German language

Handelsbezeichnung
Trade name

MKT Verbundanker V
MKT Chemical Anchor V

Zulassungsinhaber
Holder of approval

MKT
Metall-Kunststoff-Technik GmbH & Co. KG
Auf dem Immel 2
67685 Weilerbach
DEUTSCHLAND

Zulassungsgegenstand
und Verwendungszweck

Verbunddübel mit Ankerstange in den Größen M8, M10,
M12, M16, M20 und M24 zur Verankerung im ungerissenen
Beton

*Generic type and use
of construction product*

*Bonded anchor with anchor rod of sizes M8, M10, M12, M16, M20 and
M24 for use in non-cracked concrete*

Geltungsdauer:
Validity:

vom
from
bis
to
verlängert vom
extended from
bis
to

26 July 2007
24 November 2010
24 November 2010
24 November 2015

Herstellwerke
Manufacturing plants

MKT Herstellwerk 1
MKT Herstellwerk 3

Diese Zulassung umfasst
This Approval contains

15 Seiten einschließlich 6 Anhänge
15 pages including 6 annexes



Europäische Organisation für Technische Zulassungen
European Organisation for Technical Approvals

I LEGAL BASES AND GENERAL CONDITIONS

- 1 This European technical approval is issued by Deutsches Institut für Bautechnik in accordance with:
 - Council Directive 89/106/EEC of 21 December 1988 on the approximation of laws, regulations and administrative provisions of Member States relating to construction products¹, modified by Council Directive 93/68/EEC² and Regulation (EC) N° 1882/2003 of the European Parliament and of the Council³;
 - Gesetz über das In-Verkehr-Bringen von und den freien Warenverkehr mit Bauprodukten zur Umsetzung der Richtlinie 89/106/EWG des Rates vom 21. Dezember 1988 zur Angleichung der Rechts- und Verwaltungsvorschriften der Mitgliedstaaten über Bauprodukte und anderer Rechtsakte der Europäischen Gemeinschaften (Bauproduktengesetz - BauPG) vom 28. April 1998⁴, as amended by law of 31 October 2006⁵;
 - Common Procedural Rules for Requesting, Preparing and the Granting of European technical approvals set out in the Annex to Commission Decision 94/23/EC⁶;
 - Guideline for European technical approval of "Metal anchors for use in concrete - Part 5: Bonded anchors", ETAG 001-05.
- 2 Deutsches Institut für Bautechnik is authorized to check whether the provisions of this European technical approval are met. Checking may take place in the manufacturing plants. Nevertheless, the responsibility for the conformity of the products to the European technical approval and for their fitness for the intended use remains with the holder of the European technical approval.
- 3 This European technical approval is not to be transferred to manufacturers or agents of manufacturers other than those indicated on page 1, or manufacturing plants other than those indicated on page 1 of this European technical approval.
- 4 This European technical approval may be withdrawn by Deutsches Institut für Bautechnik, in particular pursuant to information by the Commission according to Article 5(1) of Council Directive 89/106/EEC.
- 5 Reproduction of this European technical approval including transmission by electronic means shall be in full. However, partial reproduction can be made with the written consent of Deutsches Institut für Bautechnik. In this case partial reproduction has to be designated as such. Texts and drawings of advertising brochures shall not contradict or misuse the European technical approval.
- 6 The European technical approval is issued by the approval body in its official language. This version corresponds fully to the version circulated in EOTA. Translations into other languages have to be designated as such.

1 Official Journal of the European Communities N° L 40, 11 February 1989, p. 12

2 Official Journal of the European Communities N° L 220, 30 August 1993, p. 1

3 Official Journal of the European Union N° L 284, 31 October 2003, p. 25

4 *Bundesgesetzblatt Teil I 1998*, p. 812

5 *Bundesgesetzblatt Teil I 2006*, p. 2407, 2416

6 Official Journal of the European Communities N° L 17, 20 January 1994, p. 34

II SPECIFIC CONDITIONS OF THE EUROPEAN TECHNICAL APPROVAL

1 Definition of the construction product and intended use

1.1 Definition of the product

The MKT Chemical anchor V is a bonded anchor consisting of a glass capsule V-P and a threaded anchor rod with hexagon nut and washer of sizes M8, M10, M12, M16, M20 and M24. The anchor rod (including nut and washer) is made of zinc-plated steel, hot-dip galvanised steel, stainless steel 1.4401, 1.4404, 1.4571, 1.4578 or 1.4362 or made of high corrosion resistant steel 1.4529 or 1.4565. The glass capsule is placed into the hole and the anchor rod is driven by machine with simultaneous hammering and turning. The anchor rod is anchored via the bond between anchor rod, chemical mortar and concrete.

An illustration of the product and intended use is given in Annex 1.

1.2 Intended use

The anchor is intended to be used for anchorages for which requirements for mechanical resistance and stability and safety in use in the sense of the Essential Requirements 1 and 4 of Council Directive 89/106 EEC shall be fulfilled and failure of anchorages made with these products would cause risk to human life and/or lead to considerable economic consequences. Safety in case of fire (Essential Requirement 2) is not covered in this European technical approval. The anchor is to be used only for anchorages subject to static or quasi-static loading in reinforced or unreinforced normal weight concrete of strength classes C20/25 at minimum and C50/60 at most according to EN 206:2000-12.

The anchor may be used in non-cracked concrete only.

The anchor may be installed in dry or wet concrete, it must not be installed in flooded holes.

Overhead installation is not admissible.

The anchor may be used in the following temperature range:

Temperature range: -40 °C to +80 °C (max long term temperature +50 °C and
max short term temperature +80 °C)

Zinc-plated or hot-dip galvanised steel:

The anchor rod, nut and washer made of zinc-plated or hot-dip galvanised steel may only be used in structures subject to dry internal conditions.

Stainless steel 1.4401, 1.4404, 1.4571, 1.4578 or 1.4362:

The anchor rod, nut and washer made of stainless steel may be used in structures subject to dry internal conditions and also in structures subject to external atmospheric exposure (including industrial and marine environment), or exposure in permanently damp internal conditions, if no particular aggressive conditions exist. Such particular aggressive conditions are e.g. permanent, alternating immersion in seawater or the splash zone of seawater, chloride atmosphere of indoor swimming pools or atmosphere with extreme chemical pollution (e.g. in desulphurization plants or road tunnels where de-icing materials are used).

High corrosion resistant steel 1.4529, 1.4565:

The anchor rod, nut and washer made of high corrosion resistant steel 1.4529 or 1.4565 may be used in structures subject to dry internal conditions and also in structures subject to external atmospheric exposure, in permanently damp internal conditions or in other particular aggressive conditions. Such particular aggressive conditions are e.g. permanent, alternating immersion in seawater or the splash zone of seawater, chloride atmosphere of indoor swimming pools or atmosphere with chemical pollution (e.g. in desulphurization plants or road tunnels where de-icing materials are used).

The provisions made in this European technical approval are based on an assumed working life of the anchor of 50 years. The indications given on the working life cannot be interpreted as a guarantee given by the producer, but are to be regarded only as a means for choosing the right products in relation to the expected economically reasonable working life of the works.

2 Characteristics of the product and methods of verification

2.1 Characteristics of the product

The anchor corresponds to the drawings and provisions given in Annexes 1 to 4. The characteristic material values, dimensions and tolerances of the anchor not indicated in Annexes 1 to 4 shall correspond to the respective values laid down in the technical documentation⁷ of this European technical approval.

The characteristic values for the design of anchorages are given in Annexes 5 and 6.

Each mortar capsule shall be marked with the identifying mark of the producer, with the capsule type and the capsule size according to Annex 1.

Each anchor rod shall be marked with the identifying mark of the producer, marking of anchorage depth (blue paint or undercut) and the anchor size in accordance with Annex 2.

2.2 Methods of verification

The assessment of fitness of the anchor for the intended use in relation to the requirements for mechanical resistance and stability and safety in use in the sense of the Essential Requirements 1 and 4 has been made in accordance with the "Guideline for European technical approval of Metal Anchors for Use in Concrete", Part 1 "Anchors in general" and Part 5 "Bonded anchors", on the basis of Option 8.

In addition to the specific clauses relating to dangerous substances contained in this European technical approval, there may be other requirements applicable to the products falling within its scope (e.g. transposed European legislation and national laws, regulations and administrative provisions). In order to meet the provisions of the Construction Products Directive, these requirements need also to be complied with, when and where they apply.

3 Evaluation and attestation of conformity and CE marking

3.1 System of attestation of conformity

According to the decision 96/582/EG of the European Commission⁸ the system 2(i) (referred to as System 1) of attestation of conformity applies.

This system of attestation of conformity is defined as follows:

System 1: Certification of the conformity of the product by an approved certification body on the basis of:

- (a) Tasks for the manufacturer:
 - (1) factory production control;

⁷ The technical documentation of this European technical approval is deposited at the Deutsches Institut für Bautechnik and, as far as relevant for the tasks of the approved bodies involved in the attestation of conformity procedure, is handed over to the approved bodies.

⁸ Official Journal of the European Communities L 254 of 08.10.1996

- (2) further testing of samples taken at the factory by the manufacturer in accordance with a prescribed control plan;
- (b) Tasks for the approved body:
 - (3) initial type-testing of the product;
 - (4) initial inspection of factory and of factory production control;
 - (5) continuous surveillance, assessment and approval of factory production control.

Note: Approved bodies are also referred to as "notified bodies".

3.2 Responsibilities

3.2.1 Tasks for the manufacturer

3.2.1.1 Factory production control

The manufacturer shall exercise permanent internal control of production. All the elements, requirements and provisions adopted by the manufacturer shall be documented in a systematic manner in the form of written policies and procedures, including records of results performed. This production control system shall insure that the product is in conformity with this European technical approval.

The manufacturer may only use initial/raw/constituent materials stated in the technical documentation of this European technical approval.

The factory production control shall be in accordance with the control plan which is part of the technical documentation of this European technical approval. The control plan is laid down in the context of the factory production control system operated by the manufacturer and deposited with Deutsches Institut für Bautechnik.⁹

The results of factory production control shall be recorded and evaluated in accordance with the provisions of the control plan.

3.2.1.2 Other tasks for the manufacturer

The manufacturer shall, on the basis of a contract, involve a body which is approved for the tasks referred to in section 3.1 in the field of anchors in order to undertake the actions laid down in section 3.2.2 For this purpose, the control plan referred to in sections 3.2.1.1 and 3.2.2 shall be handed over by the manufacturer to the approved body involved.

The manufacturer shall make a declaration of conformity, stating that the construction product is in conformity with the provisions of this European technical approval.

3.2.2 Tasks for the approved bodies

The approved body shall perform the

- initial type-testing of the product,
- initial inspection of factory and of factory production control,
- continuous surveillance, assessment and approval of factory production control,

in accordance with the provisions laid down in the control plan.

The approved body shall retain the essential points of its actions referred to above and state the results obtained and conclusions drawn in a written report.

⁹ The control plan is a confidential part of the European technical approval and only handed over to the approved body involved in the procedure of attestation of conformity. See section 3.2.2.

The approved certification body involved by the manufacturer shall issue an EC certificate of conformity of the product stating the conformity with the provisions of this European technical approval.

In cases where the provisions of the European technical approval and its control plan are no longer fulfilled the certification body shall withdraw the certificate of conformity and inform Deutsches Institut für Bautechnik without delay.

3.3 CE marking

The CE marking shall be affixed on each packaging of the anchor. The letters "CE" shall be followed by the identification number of the approved certification body, where relevant, and be accompanied by the following additional information:

- the name and address of the producer (legal entity responsible for the manufacture),
- the last two digits of the year in which the CE marking was affixed,
- the number of the EC certificate of conformity for the product,
- the number of the European technical approval,
- the number of the guideline for European technical approval,
- use category (ETAG 001-1, Option 8),
- size.

4 Assumptions under which the fitness of the product for the intended use was favourably assessed

4.1 Manufacturing

The European technical approval is issued for the product on the basis of agreed data/information, deposited with Deutsches Institut für Bautechnik, which identifies the product that has been assessed and judged. Changes to the product or production process, which could result in this deposited data/information being incorrect, should be notified to Deutsches Institut für Bautechnik before the changes are introduced. Deutsches Institut für Bautechnik will decide whether or not such changes affect the European technical approval and consequently the validity of the CE marking on the basis of the European technical approval and if so whether further assessment or alterations to the European technical approval shall be necessary.

4.2 Design of anchorages

The fitness of the anchor for the intended use is given under the following conditions:

The anchorages are designed in accordance with the "Guideline for European technical approval of Metal Anchors for Use in Concrete", Annex C, Method A, for bonded anchors under the responsibility of an engineer experienced in anchorages and concrete work.

For the verifications given below according to Annex C the following shall be observed:

- For the verification 'concrete cone failure' (clause 5.2.2.4, Annex C of the Guideline) $N_{Rk,c}$ shall be determined according to (1) and (2): The smaller of the values according to (1) and (2) is decisive.

(1) $N_{Rk,c}$ according to equation (5.2), Annex C of the Guideline

where: $N_{Rk,c}^0$ according to Annex 5, table 5

$s_{cr,N}$ according to Annex 5, table 5

$c_{cr,N}$ according to Annex 5, table 5

$\psi_{ucr,N} = 1,0$

In special cases according to clause 5.2.2.4 g, Annex C of the Guideline the method given there is valid. However, the value $N_{Rk,c}^0$ shall be calculated according to the following equation:

$$N_{Rk,c}^0 = N_{Rk,c}^0 \text{ (Annex 5, table 5)} \times \frac{h'_{ef}}{h_{ef}}$$

(2) $N_{Rk,c}$ according to equation (5.2), Annex C of the Guideline

$$\text{where: } N_{Rk,c}^0 = 0,75 \times 15,5 \times h_{ef}^{1,5} \times f_{ck,cube}^{0,5}$$

$$s_{cr,N} = 3 h_{ef}$$

$$c_{cr,N} = 1,5 h_{ef}$$

$$\psi_{ucr,N} = 1,0$$

- For the verification 'splitting failure due to loading' (clause 5.2.2.6, Annex C of the Guideline) $N_{Rk,sp}$ shall be determined according to (3).

(3) $N_{Rk,sp}$ according to equation (5.3), Annex C of the Guideline

where: $N_{Rk,c}^0$ according to Annex 5, Table 5

$s_{cr,sp}$ according to Annex 5, Table 5

$c_{cr,sp}$ according to Annex 5, Table 5

$$\psi_{ucr,N} = 1,0$$

$$\psi_{h,sp} = 1,0$$

- For the verification 'concrete pryout failure' (clause 5.2.3.3, Annex C of the Guideline) $N_{Rk,c}$ for equation (5.6), Annex C of the Guideline, shall be determined according to (1).

Verifiable calculation notes and drawings are prepared taking account of the loads to be anchored.

The position of the anchor is indicated on the design drawings (e.g. position of the anchor relative to reinforcement or to supports, etc.).

4.3 Installation of anchors

The fitness for use of the anchor can only be assumed if the anchor is installed as follows:

- anchor installation carried out by appropriately qualified personnel and under the supervision of the person responsible for technical matters of the site,
- use of the anchor only as supplied by the manufacturer without exchanging the components of an anchor,
- anchor installation in accordance with the manufacturer's specifications and drawings using the tools indicated in the technical documentation of this European technical approval,
- checks before placing the anchor to ensure that the strength class of the concrete in which the anchor is to be placed is in the range given and is not lower than that of the concrete to which the characteristic loads apply,
- check of concrete being well compacted, e.g. without significant voids,
- keeping the effective anchorage depth,
- Edge distance and spacing not less than the specified values without minus tolerances,
- positioning of the drill holes without damaging the reinforcement,
- in case of aborted drill hole: the drill hole shall be filled with mortar,
- the anchor must not be installed in flooded holes,

- cleaning the drill hole:
removing possibly existing water in the drill hole completely and cleaning the drill hole by at least one blowing operation, by at least 1 x brushing / 1 x blowing / 1 x brushing operation by using the steel brush supplied by the manufacturer; before brushing cleaning the brush and checking whether the brush diameter according to Annex 4, Table 4 is still sufficient. The steel brush shall produce natural resistance as it enters the anchor hole. If this is not the case a new brush or a brush with a larger diameter must be used.
- overhead installation is not admissible,
- the anchor component installation temperature shall be at least +5 °C; during curing of the chemical mortar the temperature of the concrete must not fall below -5 °C;
- observing the curing time according to Annex 3, Table 3 until the anchor may be loaded,
- after the curing time fixing the member to be anchored by using a calibrated torque wrench by not exceeding the torque moment given in Annex 4.

5 Indications to the manufacturer

5.1 Responsibility of the manufacturer

It is in the responsibility of the manufacturer to ensure that the information on the specific conditions according to 1 and 2 including Annexes referred to as well as sections 4.2, 4.3 and 5 is given to those who are concerned. This information may be made by reproduction of the respective parts of the European technical approval. In addition all installation data shall be shown clearly on the package and/or on an enclosed instruction sheet, preferably using illustration(s).

The minimum data required are:

- drill bit diameter,
- hole depth,
- diameter of anchor rod,
- minimum effective anchorage depth,
- information on the installation procedure, including cleaning of the hole with the cleaning equipments, preferably by means of an illustration,
- metal parts (anchor rod, washer and hexagon nut) must be of the same material and corresponding mechanical properties acc. to Annex 3, Table 2,
- anchor component installation temperature,
- ambient temperature of the concrete during installation of the anchor,
- curing time until the anchor may be loaded as a function of the ambient temperature in the concrete during installation,
- maximum torque moment,
- identification of the manufacturing batch.

All data shall be presented in a clear and explicit form.

5.2 Packaging, transport and storage

The glass capsules shall be protected against sun radiation and shall be stored according to the manufacturer's installation instructions in dry condition at temperatures of at least +5 °C to not more than +25 °C.

Glass capsules with expired shelf life must no longer be used.

The anchor shall only be packaged and supplied as a complete unit. Glass capsules may be packed separately from anchor rods (including nuts and washers).

The manufacturer's installation instruction shall indicate that the glass capsules shall be used with the anchor rods according to Annex 2.

Georg Feistel
Head of Department

beglaubigt
Lange

Glass Capsule V-P



Threaded rod V-A

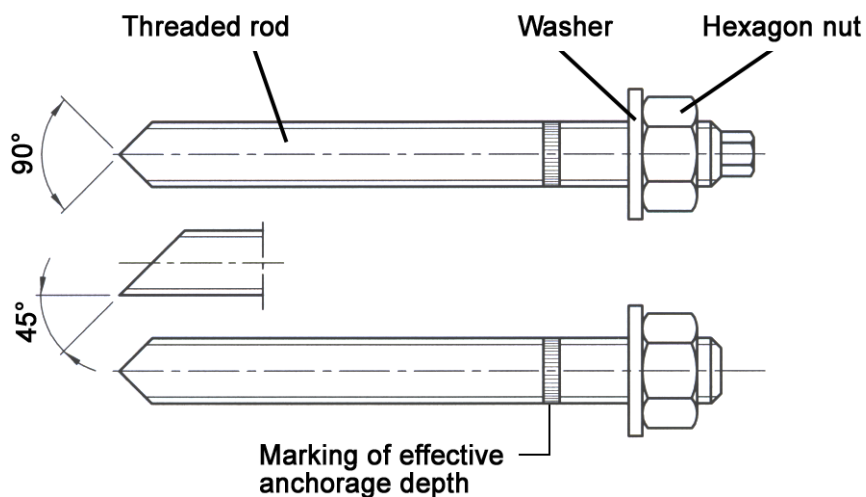

Intended use

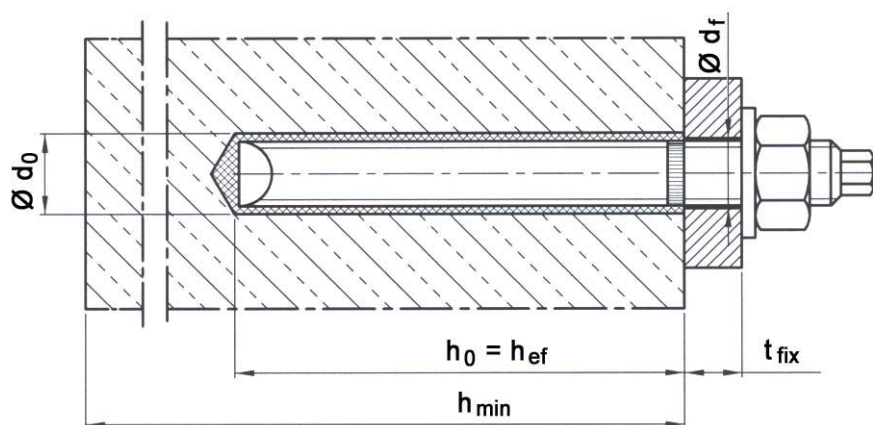

Use category

Installation in dry or wet concrete
 Service in internal conditions or external atmospheric exposure or
 in particular aggressive conditions acc. to used material.

No overhead installation.

Temperature range:

- 40°C to + 80°C (max short term temperature + 80°C and
 max long term temperature + 50°C)

MKT Chemical Anchor V

Product and intended use

Annex 1

of European
 technical approval

ETA-05/0231

Threaded rod V-A

Machined steel

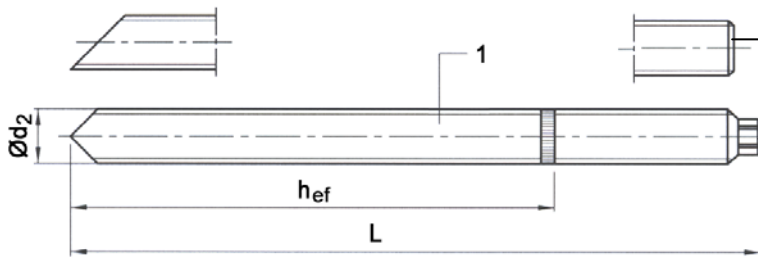

Cold formed

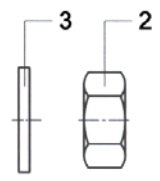
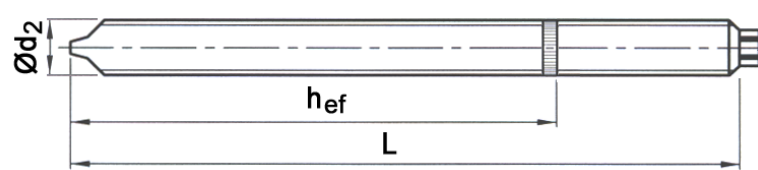

- Marking: e.g.
- ⊕ M12
 - ◇ Identifying mark of manufacturing plant additional marking of lengths for anchor size M12
 - H marking of length
 - M12 Size of thread
 - ◇ M12-8
 - 8 additional marking of steel grade 8.8
 - ◇ M12 A4
 - A4 additional marking of stainless steel A4
 - ◇ M12 HCR
 - HCR additional marking of high corrosion resistant steel HCR

Glass capsule V-P

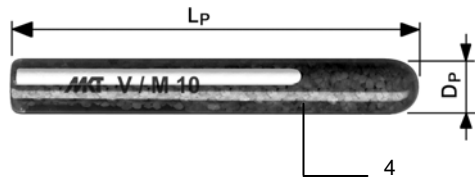

Marking of length	E	F	G	H	I	J	K
Length of anchor min \geq	88.9	101.6	114.3	127.0	139.7	152.4	165.1
Length of anchor max $<$	101.6	114.3	127.0	139.7	152.4	165.1	177.8

Marking of length	L	M	N	O	P	Q	R
Length of anchor min \geq	177.8	190.5	203.2	215.9	228.6	241.3	254.0
Length of anchor max $<$	190.5	203.2	215.9	228.6	241.3	254.0	279.4

Marking of length	S	T	U	V	W	X	Y	Z
Length of anchor min \geq	279.4	304.8	330.2	355.6	381.0	406.4	431.8	457.2
Length of anchor max $<$	304.8	330.2	355.6	381.0	406.4	431.8	457.2	483.0

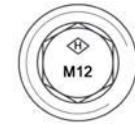

Table 1: Dimensions in mm

Anchor size			M8	M10	M12	M16	M20	M24
1	Threaded rod	$\varnothing d_2$	M8	M10	M12	M16	M20	M24
		$L^{1)} \geq$	90	100	120	140	190	235
		h_{ef}	80	90	110	125	170	210
2	Hexagon nut	SW	13	17	19	24	30	36
4	Glass capsule	D_P	9	11	13	17	22	24
		L_P	80	80	95	95	175	210

¹⁾ Other lengths on demand

Dimensions in mm

MKT Chemical Anchor V

Dimensions

Annex 2

of European technical approval

ETA-05/0231

Table 2: Materials

Part	Designation	Steel, zinc plated $\geq 5 \mu\text{m}$ acc. to EN ISO 4042	Steel, hot-dip galvanised $\geq 40 \mu\text{m}$ acc. to EN ISO 1461
1	Threaded rod	Steel, Property class 5.8, 8.8, acc. to EN ISO 898-1	Steel, Property class 5.8, 8.8, acc. to EN ISO 898-1
2	Hexagon nut according to DIN 934	Property class 8 acc. to EN 20898-2, galvanised	Property class 8 acc. to EN 20898-2, hot-dip galvanised
3	Washer	Steel, galvanised	Steel, hot-dip galvanised
4	Glass capsule	Glass, Quartz, Resin, Hardener	

Part	Designation	Stainless steel A4	High corrosion resistant steel (HCR)
1	Threaded rod	Stainless steel, 1.4401, 1.4404, 1.4571, 1.4578, 1.4362, EN 10088, Property class 70, acc. to EN ISO 3506	High corrosion resistant steel, 1.4529, 1.4565, EN 10088, Property class 70, acc. to EN ISO 3506
2	Hexagon nut according to DIN 934	Stainless steel, 1.4401, 1.4404, 1.4571, 1.4362, EN 10088, Property class 70, acc. to EN ISO 3506	High corrosion resistant steel, 1.4529, 1.4565, EN 10088, Property class 70, acc. to EN ISO 3506
3	Washer	Stainless steel, 1.4401, 1.4404, 1.4571, 1.4362, EN 10088	High corrosion resistant steel, 1.4529, 1.4565, EN 10088
4	Glass capsule	Glass, Quartz, Resin, Hardener	

Table 3: Minimum curing time

Temperature [°C] in the drill hole	Minimum curing time	
	dry concrete	wet concrete
$\geq + 35 \text{ °C}$	10 min	20 min
$\geq + 30 \text{ °C}$	10 min	20 min
$\geq + 20 \text{ °C}$	20 min	40 min
$\geq + 10 \text{ °C}$	1 h	2 h
$\geq + 5 \text{ °C}$	1 h	2 h
$\geq 0 \text{ °C}$	5 h	10 h
$\geq - 5 \text{ °C}$	5 h	10 h

MKT Chemical Anchor V**Materials,
minimum curing time.****Annex 3**of European
technical approval**ETA-05/0231**

Table 4: Installation parameters, minimum thickness of concrete, spacing and edge distance

Anchor size		M8	M10	M12	M16	M20	M24
Nominal diameter of drill hole	$d_0 =$ [mm]	10	12	14	18	25	28
Cutting diameter of drill hole	$d_{cut} \leq$ [mm]	10.5	12.5	14.5	18.5	25.5	28.5
Depth of drill hole	$h_0 \geq$ [mm]	80	90	110	125	170	210
Diameter of clearance hole in the fixture	$d_f \leq$ [mm]	9	12	14	18	22	26
Diameter of steel brush	$D \geq$ [mm]	11	13	16	20	27	30
Installation torque	T_{inst} [Nm]	10	20	40	80	120	180
Minimum thickness of concrete	$h_{min} \geq$ [mm]	110	120	140	160	220	260
Minimum spacing	$s_{min} \geq$ [mm]	40	45	55	65	85	105
Minimum edge distance	$c_{min} \geq$ [mm]	40	45	55	65	85	105



Installation procedure

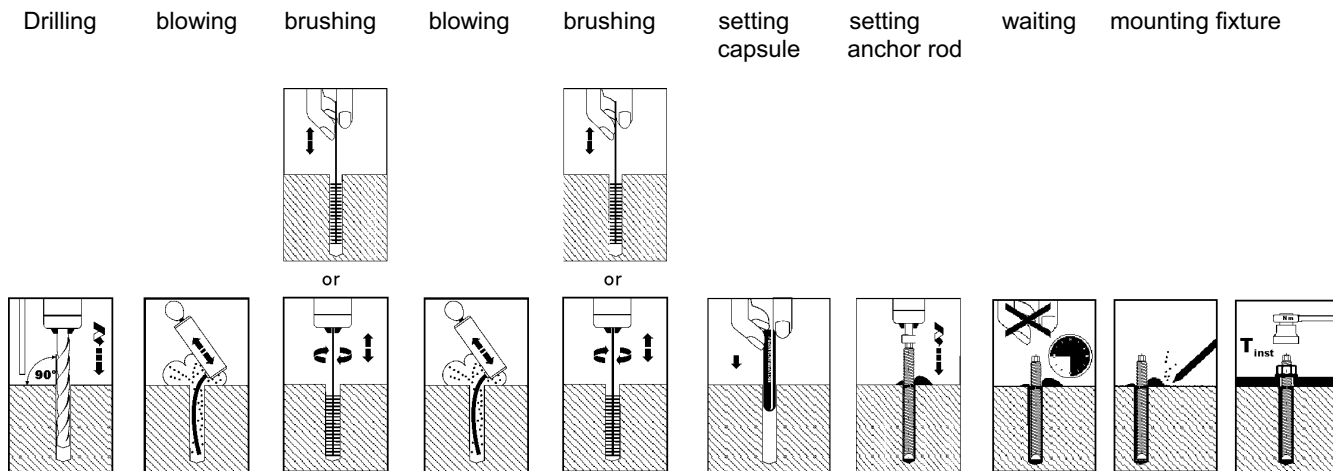

MKT Chemical Anchor V

Installation parameters, cleaning of drill hole

Annex 4

of European technical approval

ETA-05/0231

**Table 5: Design method A,
Characteristic values for tension loads**

Anchor size			M8	M10	M12	M16	M20	M24
Steel failure								
Characteristic resistance Property class 5.8	$N_{Rk,s}$	[kN]	18	29	42	78	123	177
Characteristic resistance Property class 8.8	$N_{Rk,s}$	[kN]	29	46	67	126	196	282
Partial safety factor	$\gamma_{Ms}^{1)}$	[-]	1.5					
Characteristic resistance Property class 70	$N_{Rk,s}$	[kN]	26	40	59	110	172	247
Partial safety factor	$\gamma_{Ms}^{1)}$	[-]	1.87					
Pullout failure, concrete cone failure								
Characteristic resistance in non-cracked concrete C20/25 to C50/60	$N_{Rk,p} = N_{Rk,c}^0$	[kN]	20	30	40	50	75	90
Partial safety factor	$\gamma_{Mp} = \gamma_{Mc}^{1)}$	[-]	1.8 ²⁾					
Effective anchorage depth	h_{ef}	[mm]	80	90	110	125	170	210
Characteristic spacing	$s_{cr,N}$	[mm]	3 h_{ef}	2 h_{ef}				
Characteristic edge distance	$c_{cr,N}$	[mm]	1.5 h_{ef}	1 h_{ef}				
Splitting								
Spacing	$s_{cr,Sp}$	[mm]	3 h_{ef}	2 h_{ef}				
Edge distance	$c_{cr,Sp}$	[mm]	1.5 h_{ef}	1 h_{ef}				
Partial safety factor	$\gamma_{Msp} = \gamma_{Mc}^{1)}$	[-]	1.8 ²⁾					

¹⁾ In absence of other national regulations

²⁾ The partial safety factor $\gamma_2 = 1,2$ is included

Table 6: Displacements under tension loads

Anchor size			M8	M10	M12	M16	M20	M24
Tension load	N	[kN]	8	12	16	20	30	38
Displacement	δ_{N0}	[mm]	0.1	0.2	0.2	0.2	0.5	0.4
	$\delta_{N\infty}$	[mm]	0.5					

MKT Chemical Anchor V

**Design method A,
Characteristic values for tension loads,
Displacements**

Annex 5

of European
technical approval

ETA-05/0231

**Table 7: Design method A,
Characteristic values for shear loads**

Anchor size			M8	M10	M12	M16	M20	M24	
Steel failure without lever arm									
Characteristic resistance	Property class 5.8	$V_{Rk,s}$	[kN]	9	14	21	39	61	88
	Property class 8.8	$V_{Rk,s}$	[kN]	15	23	33	63	98	141
Partial safety factor		γ_{Ms}	¹⁾ [-]	1.25					
Characteristic resistance		$V_{Rk,s}$	[kN]	13	20	29	55	86	124
Property class 70									
Partial safety factor		γ_{Ms}	¹⁾ [-]	1.56					
Steel failure with lever arm									
Characteristic bending moments		$M^0_{Rk,s}$	[Nm]	19	37	65	166	325	561
Property class 5.8									
Characteristic bending moments		$M^0_{Rk,s}$	[Nm]	30	60	105	266	519	898
Property class 8.8									
Partial safety factor		γ_{Ms}	¹⁾ [-]	1.25					
Characteristic bending moments,		$M^0_{Rk,s}$	[Nm]	26	52	92	233	454	785
Property class 70									
Partial safety factor		γ_{Ms}	¹⁾ [-]	1.56					
Concrete pryout failure									
Factor in equation (5.6)		k	[-]	2					
ETAG Annex C, 5.2.3.3									
Partial safety factor		γ_{Mcp}	¹⁾ [-]	1.5 ²⁾					
Concrete edge failure									
Effective length of anchor in shear load		l_f	[mm]	80	90	110	125	170	210
Diameter of anchor		d_{nom}	[mm]	10	12	14	18	25	28
Partial safety factor		γ_{Mc}	¹⁾ [-]	1.5 ²⁾					

¹⁾ In absence of other national regulations

²⁾ The partial safety factor $\gamma_2 = 1,0$ is included

Table 8: Displacements under shear loads

Anchor size			M8	M10	M12	M16	M20	M24
Shear load	V	[kN]	5	8	12	22	35	50
Displacements	δ_{V0}	[mm]	2	3	3	4	5	5
	$\delta_{V\infty}$	[mm]	4	5	5	6	7	7

MKT Chemical Anchor V

**Design method A,
Characteristic values for shear loads,
Displacements**

Annex 6

of European
technical approval

ETA-05/0231