

# LIFTKET

## Ersatzteilliste

STAR LIFTKET  
Elektrokettenzug





**LIFTKET Hoffmann GmbH**

Dresdener Straße 64-68

04808 Wurzen / Germany

 +49-3425-89 24-0

 +49-3425-89 24-99

 [sales@liftket.de](mailto:sales@liftket.de)

 [www.liftket.de](http://www.liftket.de)

Ho 01/2018 deutsch

## Übersicht

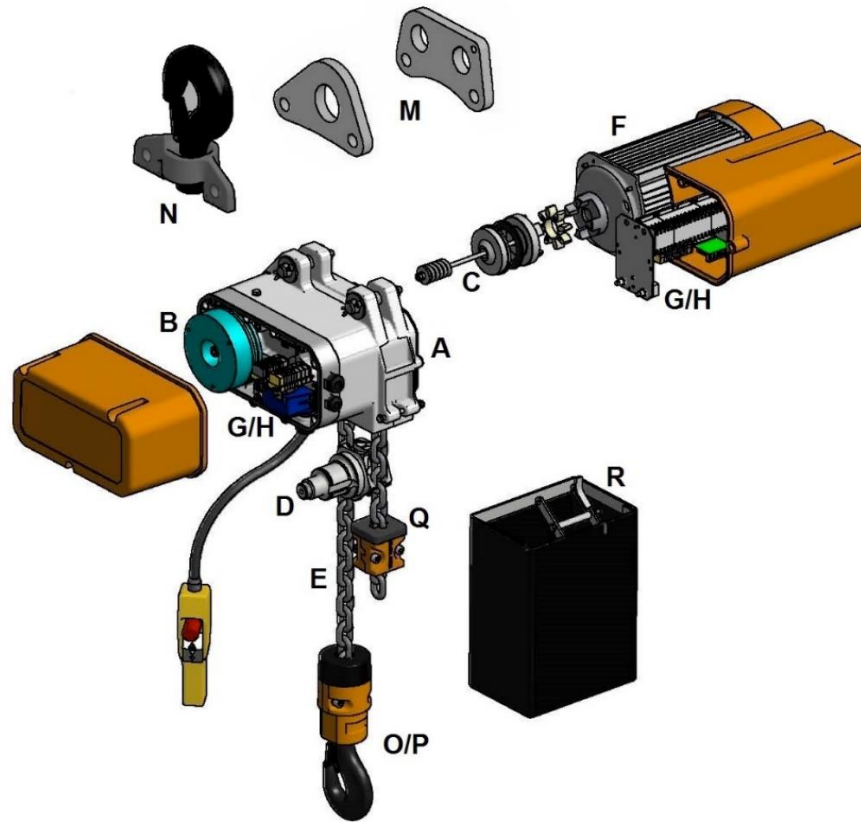

Code	Bezeichnung	Seite
A	Gehäuse	4
B	Bremse	8
C	Kupplung	9
D	Abtriebswelle	11
E	Kette	13
F	Motor	14
G	Direktsteuerung	16
H	Schützsteuerung	21
J	Elektrische Endschalter	27
M	Aufhängeösen	28
N	Hakenaufhängung	29
O	Hakenflasche	30
P	Hakengeschirr	31
Q	Hubbegrenzer	33
R	Kettenspeicher	34
Bestellformular Ersatzteile		37

## A – Gehäuse

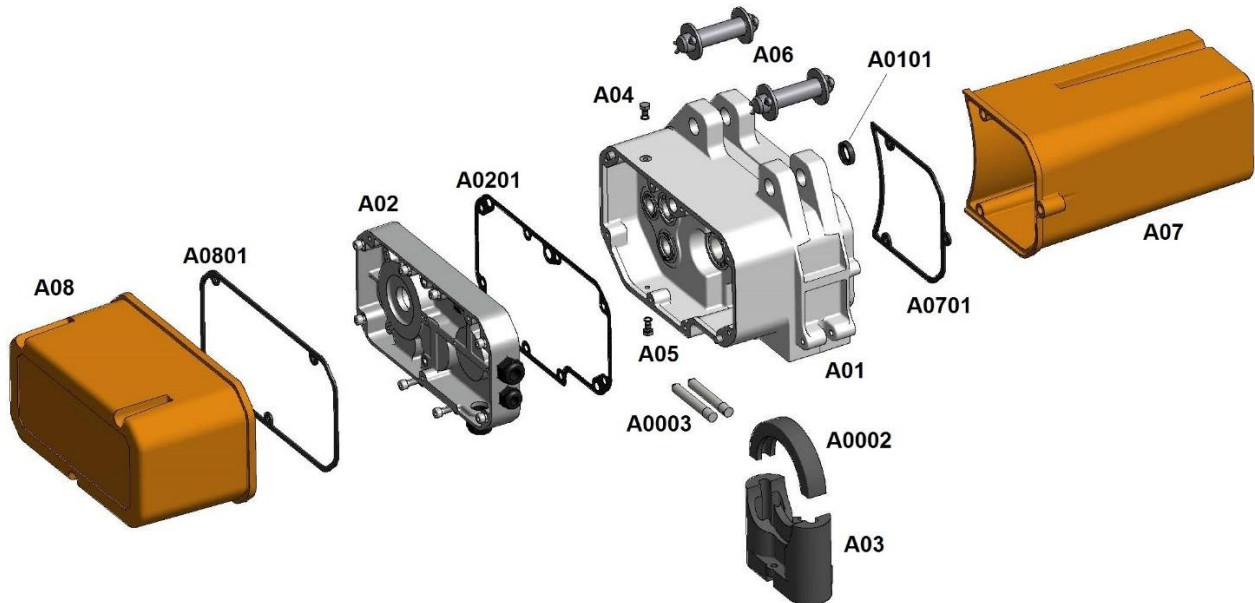

### Bauform STAR 02../..

Code	Bezeichnung	Version	Bestellnummer
A01	Gehäuse kpl.	STAR 02../..	03 9 020 52 001/1
		STAR 020/50	03 9 020 50 001/1
A0101	Wellendichtring		64 10012 02407
A02	Getriebedeckel kpl.	STAR 02../..	03 9 020 52 002/1
		STAR 020/50	03 9 020 50 002/1
A0201	Dichtung Getriebedeckel		03 0 020 50 035/0
A03	Kettenführung kpl.	mit Endschalterstift	03 9 020 50 008/1
		ohne Endschalterstift	03 8 020 50 008/0
A04	Öleinfüllschraube kpl.		01 9 00A 200/0
A05	Ölablassschraube kpl.		01 9 00A 201/0
A06	Bolzenset		03 9 020 50 210/0
A07	Kappe Steuerung kpl.		03 9 020 50 005/0
A0701	Dichtung Kappe Steuerung		03 0 020 50 039/0
A08	Kappe Getriebedeckel kpl.		03 9 020 50 004/0
A0801	Dichtung Kappe Getriebedeckel		03 0 020 50 036/0
A0002	Niederhalter		53 S0020 02900
A0003	Kettenspanne		23 S0020 00070

## Bauform STAR 03../..

Code	Bezeichnung	Version	Bestellnummer
A01	Gehäuse kpl.		03 9 020 52 001/1
A0101	Wellendichtring		64 10012 02407
A02	Getriebedeckel kpl.		03 9 020 52 002/1
A0201	Dichtung Getriebedeckel		03 0 020 50 035/0
A03	Kettenführung kpl.	mit Endschalterstift	03 9 030 50 008/1
	Kettenführung kpl.	ohne Endschalterstift	03 8 030 50 008/0
A04	Öleinfüllschraube kpl.		01 9 00A 200/0
A05	Ölablassschraube kpl.		01 9 00A 201/0
A06	Bolzenset		03 9 020 50 210/0
A07	Kappe Steuerung kpl.		03 9 020 50 005/0
A0701	Dichtung Kappe Steuerung		03 0 020 50 039/0
A08	Kappe Getriebedeckel kpl.		03 9 020 50 004/0
A0801	Dichtung Kappe Getriebedeckel		03 0 020 50 036/0
A0002	Niederhalter		53 S0030 02900
A0003	Kettenspanne		23 S0020 00070

## Bauform STAR 05../..

Code	Bezeichnung	Version	Bestellnummer
A01	Gehäuse kpl.	STAR 05../..	03 9 050 52 001/0
		STAR 051/52	03 9 051 52 001/0
A0101	Wellendichtring		64 10017 03207
A02	Getriebedeckel kpl.	STAR 05../..	03 9 050 52 002/0
		STAR 051/52	03 9 051 52 002/0
A0201	Dichtung Getriebedeckel		03 0 050 50 035/0
A03	Kettenführung kpl.	mit Endschalterstift	03 9 050 50 008/1
	Kettenführung kpl.	ohne Endschalterstift	03 8 050 50 008/0
A04	Öleinfüllschraube kpl.		01 9 00A 200/0
A05	Ölablassschraube kpl.		01 9 00A 201/0
A06	Bolzenset		03 9 070 50 210/0
A07	Kappe Steuerung kpl.		03 9 050 50 005/0
A0701	Dichtung Kappe Steuerung		03 0 050 50 039/0
A08	Kappe Getriebedeckel kpl.		03 9 050 50 004/0
A0801	Dichtung Kappe Getriebedeckel		03 0 050 50 036/0
A0002	Niederhalter		53 S0050 02900
A0003	Kettenspanne		23 S0020 00070

## Bauform STAR 07../..

Code	Bezeichnung	Version	Bestellnummer
A01	Gehäuse kpl.	STAR 07../..	03 9 070 51 001/0
		STAR 070/56	03 9 070 56 001/0
A0101	Wellendichtring		64 10017 03207
A02	Getriebedeckel kpl.		03 9 070 51 002/0
A0201	Dichtung Getriebedeckel		03 0 050 50 035/0
A03	Kettenführung kpl.	mit Endschalterstift	03 9 070 50 008/1
		ohne Endschalterstift	03 8 070 50 008/0
A04	Öleinfüllschraube kpl.		01 9 00A 200/0
A05	Ölablassschraube kpl.		01 9 00A 201/0
A06	Bolzenset	STAR 07../..	03 9 070 50 210/0
		STAR 070/56	03 9 070 56 210/0
A07	Kappe Steuerung kpl.		03 9 050 50 005/0
A0701	Dichtung Kappe Steuerung		03 0 050 50 039/0
A08	Kappe Getriebedeckel kpl.		03 9 050 50 004/0
A0801	Dichtung Kappe Getriebedeckel		03 0 050 50 036/0
A0002	Niederhalter		53 S0070 02900
A0003	Kettenspange		23 S0070 00070

## Bauform STAR 09../..

Code	Bezeichnung	Version	Bestellnummer
A01	Gehäuse kpl.		03 9 090 50 001/0
A0101	Wellendichtring		64 10020 03207
A02	Getriebedeckel kpl.		03 9 090 50 002/0
		ab Fabrik-Nr. 800000	03 9 090 50 002/1
A0202	Wellendichtring		64 10022 03507
A0201	Dichtung Getriebedeckel		03 0 090 50 035/0
A03	Kettenführung kpl.	mit Endschalterstift	03 9 090 50 008/1
		ohne Endschalterstift	03 8 090 50 008/0
A04	Öleinfüllschraube kpl.		01 9 00A 200/0
A05	Ölablassschraube kpl.		01 9 00A 201/0
A06	Bolzenset		03 9 090 50 210/0
A07	Kappe Steuerung kpl.	STAR 09../..	03 9 110 50 005/1
		STAR 091/57; 091/58	03 9 110 51 005/0
A0701	Dichtung Kappe Steuerung		03 0 090 50 039/0
A08	Kappe Getriebedeckel kpl.	STAR 09../..	03 9 090 50 004/1
		STAR 091/57; 091/58	03 9 090 20 004/1
A0801	Dichtung Kappe Getriebedeckel		03 0 090 50 036/0
A0002	Niederhalter		53 S0090 02900
A0003	Kettenspange		03 2 090 50 007/0

**Bauform STAR 11../..**

<b>Code</b>	<b>Bezeichnung</b>	<b>Version</b>	<b>Bestellnummer</b>
<b>A01</b>	Gehäuse kpl.		03 9 110 50 001/0
<b>A0101</b>	Wellendichtring		64 10020 03207
<b>A02</b>	Getriebedeckel kpl.		03 9 110 50 002/0
		ab Fabrik-Nr. 800000	03 9 110 50 002/1
<b>A0202</b>	Wellendichtring		64 10022 03507
<b>A0201</b>	Dichtung Getriebedeckel		03 0 110 50 035/0
<b>A03</b>	Kettenführung kpl.	mit Endschalterstift	03 9 110 50 008/1
	Kettenführung kpl.	ohne Endschalterstift	03 8 110 50 008/0
<b>A04</b>	Öleinfüllschraube kpl.		01 9 00A 200/0
<b>A05</b>	Ölablassschraube kpl.		01 9 00A 201/0
<b>A06</b>	Bolzenset		03 9 110 50 210/0
<b>A07</b>	Kappe Steuerung kpl.	STAR 110/52; 110/54	03 9 110 50 005/1
		STAR 111/52; 111/54	03 9 110 51 005/0
<b>A0701</b>	Dichtung Kappe Steuerung		03 0 090 50 039/0
<b>A08</b>	Kappe Getriebedeckel kpl.		03 9 090 50 004/1
<b>A0801</b>	Dichtung Kappe Getriebedeckel		03 0 090 50 036/0
<b>A0002</b>	Niederhalter		53 S0110 02900
<b>A0003</b>	Kettenspanne		03 2 110 50 007/0

## B – Bremse

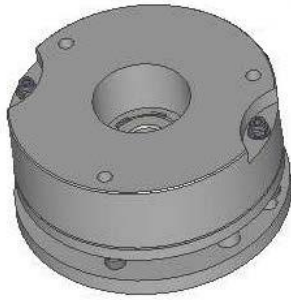

### Bauform STAR 02../..

Code	Bezeichnung	Version	Bestellnummer
B01	Federkraftbremse kpl.	STAR 02../..	17 70B06 04205
		STAR 020/01	17 70B06 04205

### Bauform STAR 03../..

Code	Bezeichnung	Version	Bestellnummer
B01	Federkraftbremse kpl.	STAR 03../..	17 70B06 04205
		STAR 030/52; 031/52	17 70B06 04205MS

### Bauform STAR 05../..

Code	Bezeichnung	Version	Bestellnummer
B01	Federkraftbremse kpl.	STAR 05../..	17 70B08 09205
		STAR 051/50; 051/52	17 70B08 06205
		STAR 050/01; 050/02	17 70B08 06205

### Bauform STAR 07../..

Code	Bezeichnung	Version	Bestellnummer
B01	Federkraftbremse kpl.	STAR 07../..	17 70B08 06205
		STAR 070/53; 070/56	17 70B08 09205
		STAR 070/01; 070/02	17 70B08 06205

### Bauform STAR 09../..

Code	Bezeichnung	Version	Bestellnummer
B01	Federkraftbremse kpl.	STAR 090/52; 091/51; 091/52	17 70B10 12205
		STAR 090/54; 090/55; 091/56; 091/57; 091/58	17 70B12 22205

### Bauform STAR 11../..

Code	Bezeichnung	Version	Bestellnummer
B01	Federkraftbremse kpl.	STAR 11../..	17 70B12 22205



## C – Kupplung

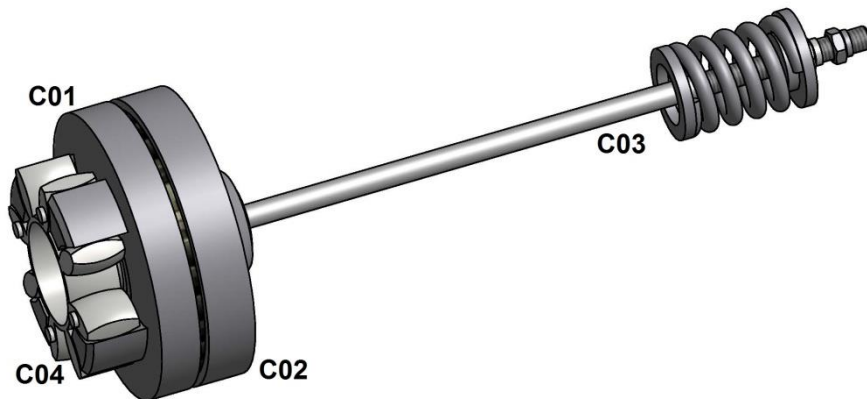

### Bauform STAR 02../..

Code	Bezeichnung	Version	Bestellnummer
C01	Kupplungstreibscheibe kpl.		14 2 020 50 003/1
C02	Kupplungsscheibe kpl.		14 9 020 50 005/0
C03	Zubehörset Rutschkupplung	STAR 02../..	14 9 020 50 010/0
		STAR 020/52; 021/52	14 9 020 52 010/0
C04	Zahnkranz		54 00240 05502

### Bauform STAR 03../..

Code	Bezeichnung	Version	Bestellnummer
C01	Kupplungstreibscheibe kpl.		14 2 020 50 003/1
C02	Kupplungsscheibe kpl.		14 9 020 50 005/0
C03	Zubehörset Rutschkupplung	STAR 03../..	14 9 020 50 010/0
		STAR 030/52; 031/52	14 9 030 52 010/0
C04	Zahnkranz		54 00240 05502

### Bauform STAR 05../..

Code	Bezeichnung	Version	Bestellnummer
C01	Kupplungstreibscheibe kpl.		14 2 050 50 003/1
C02	Kupplungsscheibe kpl.		14 9 050 50 005/0
C03	Zubehörset Rutschkupplung		14 9 050 50 010/0
C04	Zahnkranz		54 00240 05502

### Bauform STAR 07../..

Code	Bezeichnung	Version	Bestellnummer
C01	Kupplungstreibscheibe kpl.		14 2 050 50 003/1
C02	Kupplungsscheibe kpl.		14 9 050 50 005/0
C03	Zubehörset Rutschkupplung		14 9 050 50 010/0
C04	Zahnkranz		54 00240 05502

## Bauform STAR 09../..

Code	Bezeichnung	Version	Bestellnummer
C01	Kupplungstreibscheibe kpl.		14 2 090 50 003/0
C02	Kupplungsscheibe kpl.		14 9 090 50 005/0
		ab Fabrik-Nr. 800000	14 9 090 50 005/1
C03	Zubehörset Rutschkupplung	STAR 09../..	14 9 090 50 010/0
		STAR 090/52; 091/51; 091/52	14 9 090 51 010/0
C04	Zahnkranz		54 00380 09502
		bis Fabrik-Nr. D20758	54 00380 09502/ET

## Bauform STAR 11../..

Code	Bezeichnung	Version	Bestellnummer
C01	Kupplungstreibscheibe kpl.		14 2 090 50 003/0
C02	Kupplungsscheibe kpl.		14 9 090 50 005/0
		ab Fabrik-Nr. 800000	14 9 090 50 005/1
C03	Zubehörset Rutschkupplung		14 9 090 50 010/0
C04	Zahnkranz		54 00380 09502
		bis Fabrik-Nr. D20758	54 00380 09502/ET

## Montagewerkzeug

Code	Bezeichnung	Version	Bestellnummer
C05	Bit für Kopfbundschraube (Zugstange)	STAR 02../..; 03../..	91 01000 00050
		STAR 05../..; 07../..	91 01000 00060
		STAR 09../..; 11../..	91 01000 00080

## D – Abtriebswelle

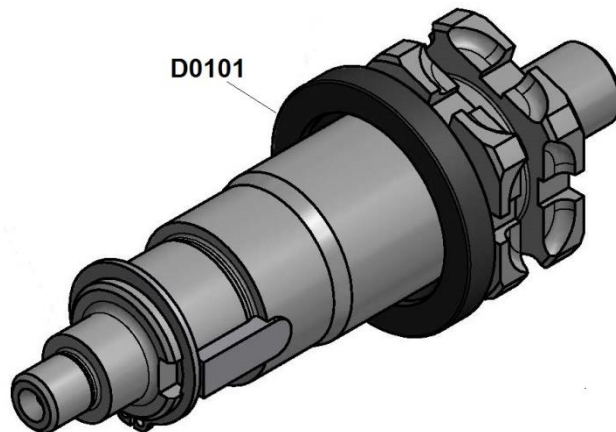

### Bauform STAR 02../.

Code	Bezeichnung	Version	Bestellnummer
D01	Abtriebswelle kpl.		03 9 020 50 025/0
D0101	Wellendichtring		64 10035 05207
D0102	Wellendichtring		64 10012 02407
A0201	Dichtung Getriebedeckel		03 0 020 50 035/0

### Bauform STAR 03../.

Code	Bezeichnung	Version	Bestellnummer
D01	Abtriebswelle kpl.		03 9 030 50 025/0
D0101	Wellendichtring		64 10035 05207
D0102	Wellendichtring		64 10012 02407
A0201	Dichtung Getriebedeckel		03 0 020 50 035/0

### Bauform STAR 05../.

Code	Bezeichnung	Version	Bestellnummer
D01	Abtriebswelle kpl.		03 9 050 50 025/0
D0101	Wellendichtring		64 10045 07510
D0102	Wellendichtring		64010017 03207
A0201	Dichtung Getriebedeckel		03 0 050 50 035/0

### Bauform STAR 07../.

Code	Bezeichnung	Version	Bestellnummer
D01	Abtriebswelle kpl.		03 9 070 50 025/0
D0101	Wellendichtring		64 10045 07510
D0102	Wellendichtring		64 10017 03207
A0201	Dichtung Getriebedeckel		03 0 050 50 035/0

## Bauform STAR 09../..

Code	Bezeichnung	Version	Bestellnummer
D01	Abtriebswelle kpl.		03 9 090 50 025/0
		ab Fabrik-Nr.800000	03 9 090 50 025/1
D0101	Wellendichtring		64 10065 10010
D0102	Wellendichtring		64 10020 03207
		ab Fabrik-Nr.800000	64 10022 03507
D01001	Dichtscheibe		96 NJ000 00205NI
A0201	Dichtung Getriebedeckel		03 0 090 50 035/0

## Bauform STAR 11../..

Code	Bezeichnung	Version	Bestellnummer
D01	Abtriebswelle kpl.		03 9 110 50 025/0
		ab Fabrik-Nr.800000	03 9 110 50 025/1
D0101	Wellendichtring		64 10085 12010
D0102	Wellendichtring		64 10020 03207
		ab Fabrik-Nr.800000	64 10022 03507
D01001	Dichtscheibe		96 NI000 00206NI
A0201	Dichtung Getriebedeckel		03 0 110 50 035/0

**E – Kette****Bauform STAR 02../..**

Code	Bezeichnung	Version	Bestellnummer
E01	Kette	4x12 mm	47 04012 00002V

**Bauform STAR 03../..; STAR 05../..**

Code	Bezeichnung	Version	Bestellnummer
E01	Kette	5,2x15 mm	47 05215 00002V

**Bauform STAR 07../..**

Code	Bezeichnung	Version	Bestellnummer
E01	Kette	7,2x21 mm	47 07221 00002V

**Bauform STAR 09../..**

Code	Bezeichnung	Version	Bestellnummer
E01	Kette	9x27 mm	47 09027 00002V

**Bauform STAR 11../..**

Code	Bezeichnung	Version	Bestellnummer
E01	Kette	11,3x31 mm	47 11331 00005V

## F – Motor

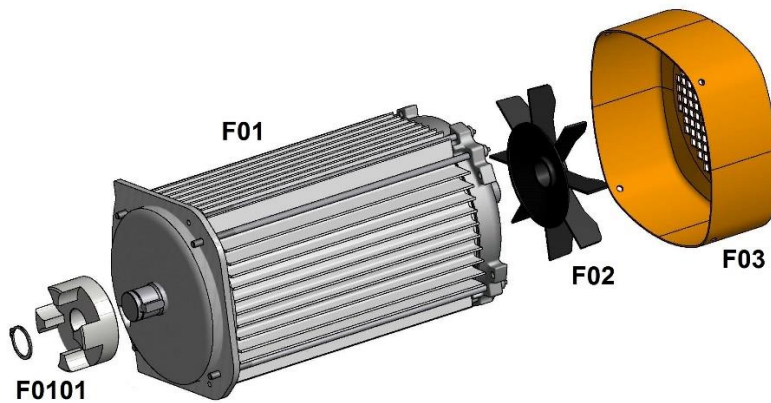

LIFTKET			
LIFTKET Hoffmann GmbH www.liftket.de ELEKTROKETTENZUG / ELECTRIC CHAIN HOIST Made in Germany			
Typ / Type 050/95	Fabrik-Nr. / Serial no. H35453	Baujahr / Fabr. year 07/2017	
S.W.L. (kg) (m/min)	1/1 500 18,0	5,2x15 mm FEM/ISO 60% ED	EN 818-7 1Bm/M3 240 S/h
KLOR 80G2	690 V;	50 Hz;	3 ph F; IP 55
1,5 kW 1,68 A	cos φ 0,90		2850 min <sup>-1</sup>



### Bauform STAR 02../..

Code	Bezeichnung	gemäß Typenschild	Bestellnummer
F01	Motor kpl. 400V, 50Hz, 3ph (andere Spannungen auf Anfrage)	63K2	42 9 063K20 000/0
		63G2	42 9 063G20 000/0
		63G8/2	42 9 063G82 000/0
F01	Motor kpl. 230V, 50Hz, 1ph~	63G2	42 9 063G20E 000/0
F0101	Kupplungsnabe kpl.		14 9 020 50 001/0
F02	Lüfterflügel		53 S0055 00560
F03	Lüfterkappe		42 9 063K40 011/0

### Bauform STAR 03../..

Code	Bezeichnung	gemäß Typenschild	Bestellnummer
	Motor kpl. 400V, 50Hz, 3ph (andere Spannungen auf Anfrage)	63G2	42 9 063G20 000/0
		63G8/2	42 9 063G82 000/0
F0101	Kupplungsnabe kpl.		14 9 020 50 001/0
F02	Lüfterflügel		53 S0055 00560
F03	Lüfterkappe		42 9 063K40 011/0

## Bauform STAR 05../..

Code	Bezeichnung	gemäß Typenschild	Bestellnummer
F01	Motor kpl. 400V, 50Hz, 3ph (andere Spannungen auf Anfrage)	71G2	42 9 071G20 000/0
		71G4	42 9 071G40 000/0
		71G8/2	42 9 071G82 000/0
		80G8/2	42 9 080G82 000/0
F01	Motor kpl. 230V, 1ph~	71G2	42 9 071G20E 000/0
F0101	Kupplungsnabe kpl.		14 9 050 50 001/0
F02	Lüfterflügel		53 S0055 00780
F03	Lüfterkappe		42 9 071G40 011/0

## Bauform STAR 07../..

Code	Bezeichnung	gemäß Typenschild	Bestellnummer
F01	Motor kpl. 400V, 50Hz, 3ph (andere Spannungen auf Anfrage)	71G2	42 9 071G20 000/0
		80G2	42 9 080G20 000/0
		80G8/2	42 9 080G82 000/0
		Motor kpl. 230V, 1ph~	80G2
F0101	Kupplungsnabe kpl.		14 9 050 50 001/0
F02	Lüfterflügel		53 S0055 00780
F03	Lüfterkappe		42 9 071G40 011/0

## Bauform STAR 09../..

Code	Bezeichnung	gemäß Typenschild	Bestellnummer
F01	Motor kpl. 400V, 50Hz, 3ph (andere Spannungen auf Anfrage)	90L2	42 9 090L20 000/0
		90L4	42 9 090L40 000/0
		90L8/2	42 9 090L82 000/0
		100L8/2	42 9 100L82 000/0
		100LV8/2	42 9 100V82 000/0
F0101	Kupplungsnabe kpl.		14 9 090 50 001/0
F0102	Lüfterflügel	90L2, 90L4, 90L8/2	53 S0055 00900
		100L8/2, 100LV8/2	53 S0055 01000
F0103	Lüfterkappe	90L2, 90L4, 90L8/2	42 9 090L20 011/0
		100L8/2, 100LV8/2	42 9 100V82 011/0

## Bauform STAR 11../..

Code	Bezeichnung	gemäß Typenschild	Bestellnummer
F01	Motor kpl. 400V, 50Hz, 3ph (andere Spannungen auf Anfrage)	100S2	42 9 100S20 000/0
		100LV8/2	42 9 100V82 000/0
F0101	Kupplungsnabe kpl.		14 9 090 50 001/0
F0102	Lüfterflügel		53 S0055 01000
F0103	Lüfterkappe		42 9 100V82 011/0

## Montagewerkzeug

Code	Bezeichnung	Bestellnummer
F0104	Bit für Kopfbundschrabe (Zuganker)	91 01000 00060

## G – Direktsteuerung

### Direktsteuerung 400V, 3ph komplett

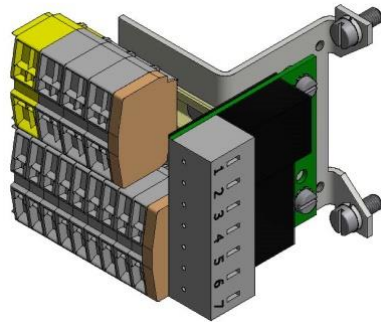

Code	Bezeichnung	Version	Bestellnummer
G11	Direktsteuerung kpl.	1 Hubgeschwindigkeit	10 9 020 50 000/1

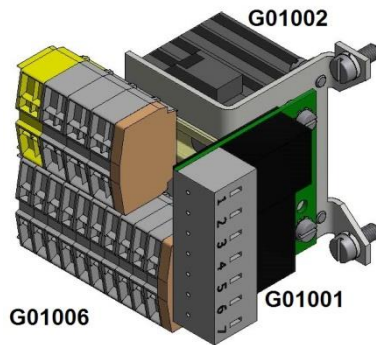

Code	Bezeichnung	Version	Bestellnummer
G12	Direktsteuerung kpl.	2 Hubgeschwindigkeiten	10 9 021 50 000/0

### Direktsteuerung 230V, 1ph komplett

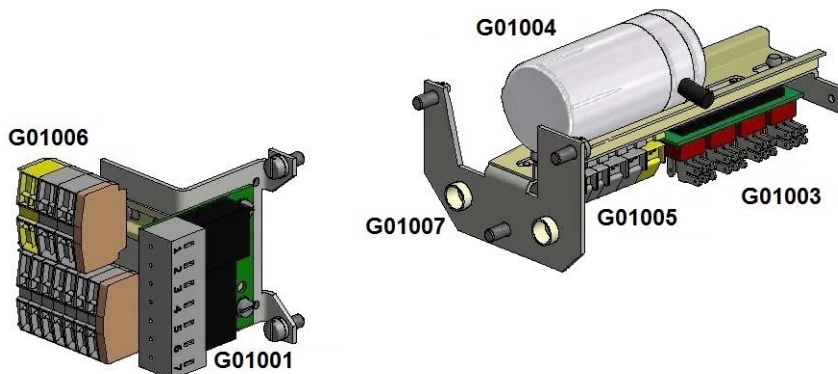

Code	Bezeichnung	Version	Bestellnummer
G13	Direktsteuerung kpl.	STAR 020/0..	10 9 020 02 000/0
		STAR 050/0..	10 9 050 01 000/0
		STAR 070/0..	10 9 070 01 000/0



## Komponenten

**Code**    **Bezeichnung**

**G01001**    Gleichrichter



**Version**

**Bestellnummer**

20 00040 00040F

**G01002**    Bremshilfsschütz



74 3LC1S K0624

Stromschütz

Type 1 – 115 Windungen    11 0 10D LC1/0

Type 2 – 455 Windungen    11 0 10A LC1/0



Type 3 – 66 Windungen    11 0 090 15 LC1/0

Type 4 – 197 Windungen    11 0 050 00 LC1/0

**G01003**    Elektronikstarter 230V, 1ph~

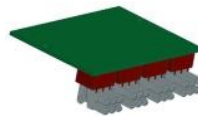

74 40060 02220

**G01004**    Kondensator 230V, 1ph~



STAR 020/01

20 00100 00041

STAR 050/01

20 00100 00060

STAR 070/01

20 00100 00125

**G01005**    Set Reihenklemmen (Motorseite)



11 9 020 50 500/0

**G01006**    Set Reihenklemmen (Bremsseite)



STAR 020/..

11 9 020 01 500/0

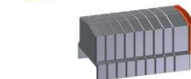

STAR 050/.. - 111/..



















































11 9 050 50 500/0

**G01007**    Abdeckstopfen











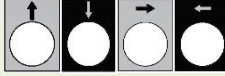

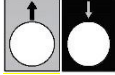

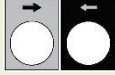

53 SA000 00203













































## Hängetaster komplett

Code	Bezeichnung	Symbol / Funktion	Bestellnummer
G02	Hängetaster	 	81 B0100 00000
		  	81 B0100 000NH
		  für 1ph EKZ	81 B0100 AK000
		   für 1ph EKZ	81 B0100 AK0NH
		   	81 B0101 00000
		    	81 B0101 000NH
		   	81 B0102 00000
		    	81 B0102 000NH
		 	81 B0200 00000
		  	81 B0200 000NH
		   	81 B0201 00000
		    	81 B0201 000NH
		   	81 B0202 00000
		    	81 B0202 000NH

## Hängetaster / Komponenten

Code	Bezeichnung		Symbol / Funktion	Bestellnummer
G0202	Schalteinsatz		 bis 3,0 kW	81 XES0D 02201
			 für 1ph EKZ	81 XES0D 02241
			 bis 2,0 kW	81 XES0D 01191
			 bis 2,2 kW	81 XES0D 01291
G0203	NOT-Halt-Knopf			81 XAC0S 00499
				81 ZA2BS 00054
G0204	Gummiteile für Befehlsstellen 1-stufige Funktion		weiß	81 XAC0B 09111
			schwarz	81 XAC0B 09112
	Gummiteile für Befehlsstellen 2-stufige Funktion		weiß	81 XAC0B 09211
			schwarz	81 XAC0B 09212

## Hängetaster / Steuerkabel

Code	Bezeichnung	Symbol / Funktion		Bestellnummer
G0201	Steuerkabel	 	7x1,5	45 0YMH0 07015
		  	7x1,5	45 0YMH0 07015
		   	8x1,5	45 0YMH0 08015
		    	8x1,5	45 0YMH0 08015
		   	12x1,5	45 0YMH0 12015
		    	12x1,5	45 0YMH0 12015
		 	7x1,5	45 0YMH0 07015
		  	7x1,5	45 0YMH0 07015
		   	10x1,5	45 0YMH0 10015
		    	10x1,5	45 0YMH0 10015
		   	12x1,5	45 0YMH0 12015
		    	12x1,5	45 0YMH0 12015

## H – Schützsteuerung

Schützsteuerung 400V / 24V / 3ph komplett

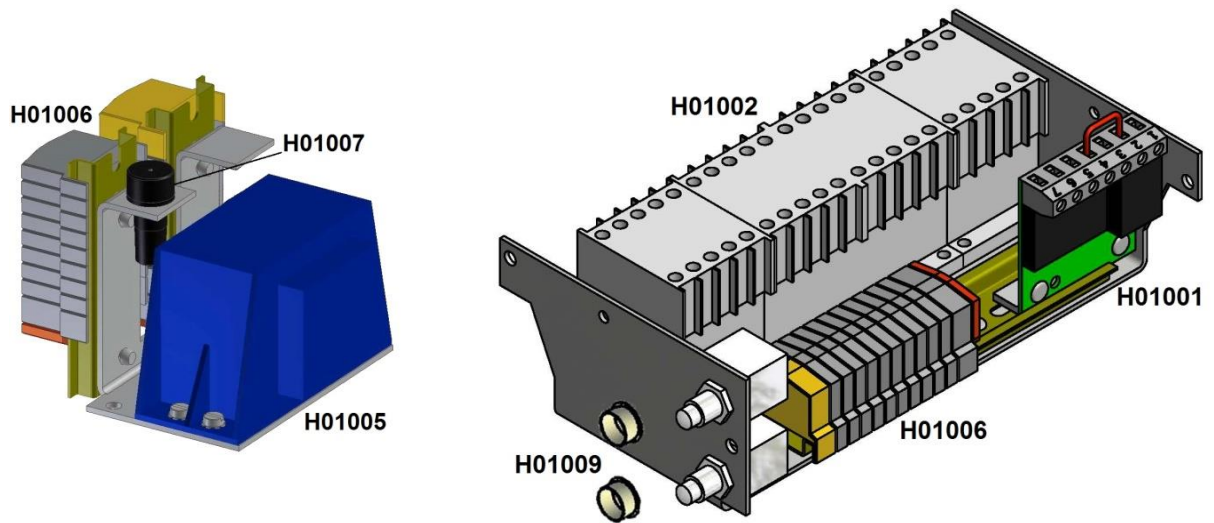

Code	Geschwindigkeit		NOT-Halt		Endschalter	
	eine	zwei	mit	ohne	mit	ohne
H0101	x		x			x
H0102	x		x		x	
H0103	x			x		x
H0104	x			x	x	
H0105		x	x			x
H0106		x	x		x	
H0107		x		x		x
H0108		x		x	x	

Code	STAR 02../.., 03../..	STAR 05../..	STAR 07../..
H0101	11 2 020 011N 00/4	11 2 050 011N 00/4	11 2 070 011N 00/4
H0102	11 2 020 011NE 00/4	11 2 050 011NE 00/4	11 2 070 011NE 00/4
H0103	11 2 020 011 00/4	11 2 050 011 00/4	11 2 070 011 00/4
H0104	11 2 020 011 E 00/4	11 2 050 011 E 00/4	11 2 070 011 E 00/4
H0105	11 2 021 011N 00/4	11 2 051 011N 00/4	11 2 071 011N 00/4
H0106	11 2 021 011NE 00/4	11 2 051 011NE 00/4	11 2 071 011NE 00/4
H0107	11 2 021 011 00/4	11 2 051 011 00/4	11 2 071 011 00/4
H0108	11 2 021 011 E 00/4	11 2 051 011 E 00/4	11 2 071 011 E 00/4

Code	STAR 09../..	STAR 11../..
H0101	11 2 090 011N 00/4	11 2 110 011N 00/4
H0102	11 2 090 011NE 00/4	11 2 110 011NE 00/4
H0103	11 2 090 011 00/4	11 2 110 011 00/4
H0104	11 2 090 011 E 00/4	11 2 110 011 E 00/4
H0105	11 2 091 011N 00/4	11 2 111 011N 00/4
H0106	11 2 091 011NE 00/4	11 2 111 011NE 00/4
H0107	11 2 091 011 00/4	11 2 111 011 00/4
H0108	11 2 091 011 E 00/4	11 2 111 011 E 00/4

## Schützsteuerung 230V / 24V / 1ph komplett

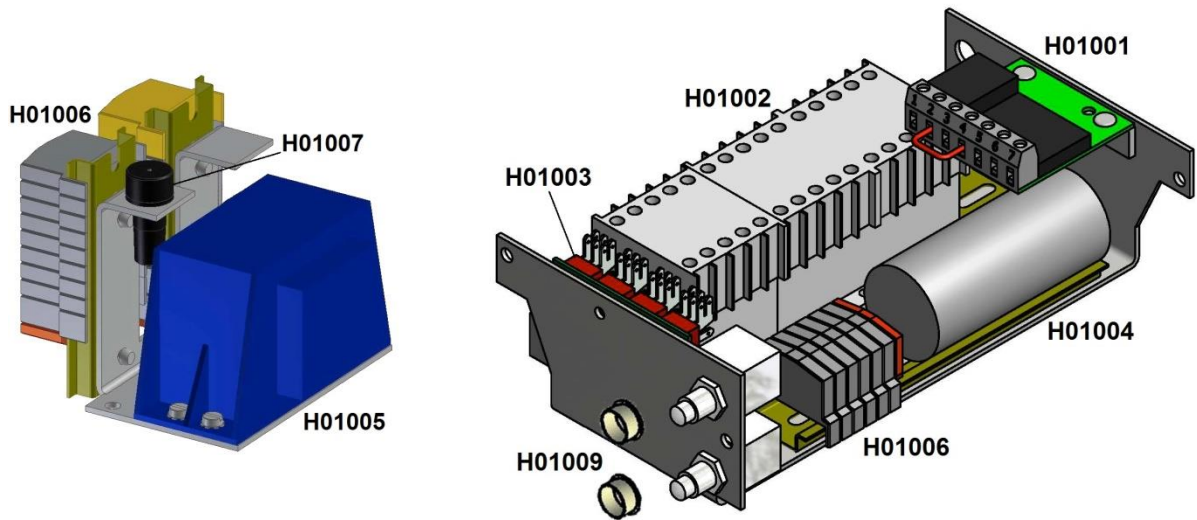















































Code	NOT-Halt		Endschalter	
	mit	ohne	mit	ohne
H0109	x			x
H0110	x		x	
H0111		x		x
H0112		x	x	

Code	STAR 02../..	STAR 05../..	STAR 07../..
H0109	11 2 020 101N 00/1	11 2 050 101N 00/1	11 2 070 101N 00/1
H0110	11 2 020 101NE 00/1	11 2 050 101NE 00/1	11 2 070 101NE 00/1
H0111	11 2 020 101 00/1	11 2 050 101 00/1	11 2 070 101 00/1
H0112	11 2 020 101 E 00/1	11 2 050 101 E 00/1	11 2 070 101 E 00/1

## Komponenten









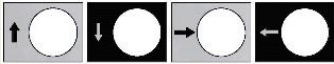

Code	Bezeichnung	Version	Bestellnummer
H01001	Gleichrichter		20 00040 00040F
H01002	Schütz K1,	STAR 020/..., 021/...; STAR 030/..., 031/...	74 3DSL3 01024UL <b>bis 02/16</b>
	Schütz K2, K3	STAR 020/..., 021/...; STAR 030/..., 031/... STAR 050/... - 110/...; STAR 051/... - 111/..	74 3B005 10024 <b>ab 03/16</b> 74 3LC1K 91024
	Schütz K4	STAR 020/..., 021/...; STAR 030/..., 031/... STAR 050/... - 110/...; STAR 051/... - 111/..	74 3DSL3 10024 <b>bis 02/16</b> 74 3BW05 10024 <b>ab 03/16</b> 74 3LC2K 91024
H01003	Elektronikstarter 230V, 1ph~	STAR 021/..., 031/... STAR 051/..., 071/...; 091/..., 111/..	74 3DSL3 22024UL <b>bis 02/16</b> 74 3B005 22024 <b>ab 03/16</b> 74 3LC1K 98024
H01004	Kondensator	STAR 020/0.. - STAR 070/0..	74 40060 02220
H01005	Transformator 230-400V/24V	STAR 020/0.. STAR 050/0.. STAR 070/0.. STAR 020/..., 021/...; STAR 030/..., 031/... STAR 050/... - 110/...; STAR 051/... - 111/..	20 00100 00041 20 00100 00060 20 00100 00125 88 00400 UI024 88 00400 EI024
H01006	Set Reihenklemmen	STAR 020/..., 021/...; STAR 030/..., 031/... STAR 050/... - 110/...; STAR 051/... - 111/..	11 9 020 50 500/0 11 9 050 50 500/0
H01007	Sicherungshalter	Primär	20 00060 00080
		Sekundär	20 00060 00086
H01008	Feinsicherung	1,25 A	20 00060 00082
H01009	Abdeckstopfen		53 SA000 00202

## Hängetaster komplett











Code	Bezeichnung	Symbol / Funktion	Bestellnummer
H02	Hängetaster	 	81 A0100 00000
		  	81 A0100 000NH
		   	81 A0101 00000
		    	81 A0101 000NH
		   	81 A0102 00000
		    	81 A0102 000NH
		 	81 A0200 00000
		  	81 A0200 000NH
		   	81 A0201 00000
		    	81 A0201 000NH
		   	81 A0202 00000
		    	81 A0202 000NH



## Hängetaster / Komponenten

Code	Bezeichnung		Symbol / Funktion	Bestellnummer
H0202	Schalteinsatz			81 ZB2BE 00101
				81 ZB2BE 00201
				81 XEN0G 01191
				81 ZB2BE 00102
				81 ZA2BS 00834
H0203	NOT-Halt-Knopf			
H0204	Gummiteile für Befehlsstellen		weiß	81 XAC0A 09411
			schwarz	81 XAC0A 09412

## Hängetaster / Steuerkabel

Code	Bezeichnung	Symbol / Funktion		Bestellnummer
H0201	Steuerkabel	 	4G1,5	45 0H070 04G15
		  	5G1,5	45 0H070 05G15
		   	7G1,5	45 0YMH0 07G15
		    	7G1,5	45 0YMH0 07G15
		   	7G1,5	45 0YMH0 07G15
		    	12G1,5	45 0H070 12G15
		 	5G1,5	45 0H070 05G15
		  	7G1,5	45 0YMH0 07G15
		   	7G1,5	45 0YMH0 07G15
		    	12G1,5	45 0H070 12G15
		   	12G1,5	45 0H070 12G15
		    	12G1,5	45 0H070 12G15

## J – Elektrische Endschalter

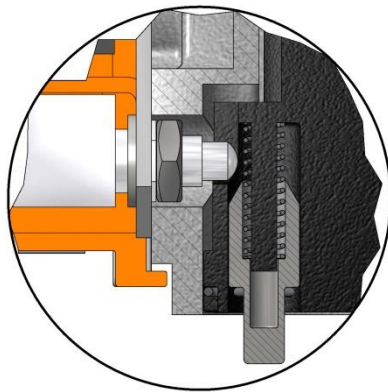
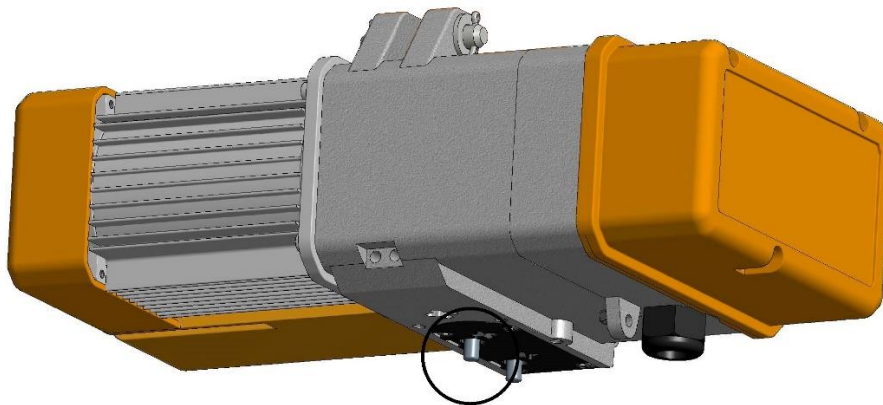

**J01**



**J02**

Code	Bezeichnung	Version	Bestellnummer
<b>J01</b>	Elektrischer Endschalter kpl.		46 9 020 50 217/0
<b>J02</b>	Endschalterstift kpl.	STAR 02../.., 03../..	46 9 020 50 300/1
		STAR 05../.., 07../..	46 9 050 50 300/1
		STAR 09../..	46 9 090 50 300/1
		STAR 11../..	46 9 110 50 300/1

## M - Aufhängeösen

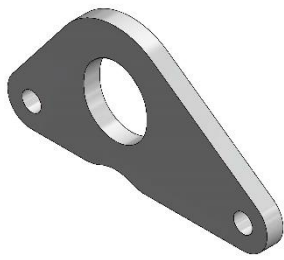

**M01**

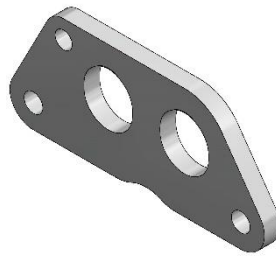

**M02**



**M03**

Code	Bezeichnung	Version		Bestellnummer		
<b>M01</b>	Einlochaufhängeöse	STAR 02../.., 030/50	500 kg	55 0 020 50 003/0		
		STAR 030/..	1000 kg	55 0 030 50 004/1		
		STAR 05../..	1000 kg	55 0 050 50 002/0		
		STAR 07../..	2000 kg	55 0 070 50 004/0		
		STAR 070/56	2500 kg	55 0 070 56 004/0		
		STAR 09../..	3200 kg	55 0 090 50 004/0		
		STAR 11../..	6300 kg	55 0 110 50 003/0		
		<b>M02</b>	Zweilochaufhängeöse	STAR 02../.., 030/50	500 kg	55 0 020 50 002/1
STAR 030/..	1000 kg			N 55 0 030 50 001/0		
				S1 55 0 030 50 002/0		
				S2 55 0 030 50 003/0		
STAR 05../..	500 kg			55 0 070 50 001/0		
STAR 050/53	1000 kg			N 55 0 070 50 001/0		
				S1 55 0 070 50 002/0		
				S2 55 0 070 50 003/0		
STAR 07../..	2000 kg			N 55 0 070 50 001/0		
				S1 55 0 070 50 002/0		
				S2 55 0 070 50 003/0		
STAR 070/56	2500 kg			N 55 0 070 56 001/0		
				S1 55 0 070 56 002/0		
				S2 55 0 070 56 003/0		
STAR 09../..	3200 kg			N 55 0 090 50 001/0		
				S1 55 0 090 50 002/0		
				S2 55 0 090 50 003/0		
STAR 11../..	6300 kg			N 55 0 110 50 001/0		
				S1 55 0 110 50 001/0		
				S2 55 0 110 50 002/0		
<b>M03</b>	Bolzenset			STAR 02../.., 03../..		03 9 020 50 210/0
				STAR 05../.., 07../..		03 9 070 50 210/0
				STAR 070/56		03 9 070 56 210/0
				STAR 09../..		03 9 090 50 210/0
		STAR 11../..		03 9 110 50 210/0		

## N - Hakenaufhängung



N01



N0101



N02

Code	Bezeichnung	Version		Bestellnummer		
N01	Hakenaufhängung	STAR 02../.., 03../..	drehbar	56 2 020 50 SW0/0		
			nicht drehbar	56 2 020 51 SW0/0		
		STAR 05../..	drehbar	56 2 050 50 SW0/0		
			nicht drehbar	56 2 050 51 SW0/0		
		STAR 07../..	drehbar	56 2 070 50 SW0/0		
			nicht drehbar	56 2 070 51 SW0/0		
		STAR070/56	drehbar	56 2 070 56 SW0/0		
			nicht drehbar	56 2 070 57 SW0/0		
		STAR 09../..	drehbar	56 2 090 50 SW0/0		
			nicht drehbar	56 2 090 51 SW0/0		
		STAR 11../..	drehbar	56 2 110 50 SW0/0		
			nicht drehbar	56 2 110 51 SW0/0		
		N0101	Hakensicherung	STAR 02../.. – 05../..		20 9 020 50 003/0
						20 9 070 50 003/1
STAR 09../..				20 9 090 50 003/0		
STAR 11../..				20 9 110 50 003/1		
N02	Bolzenset	STAR 02../.., 03../..		03 9 020 50 210/0		
				03 9 070 50 210/0		
		STAR 07../..		03 9 070 50 210/0		
		STAR070/56		03 9 070 56 210/0		
		STAR 09../..		03 9 090 50 210/0		
		STAR 11../..		03 9 110 50 210/0		

## O - Hakenflasche

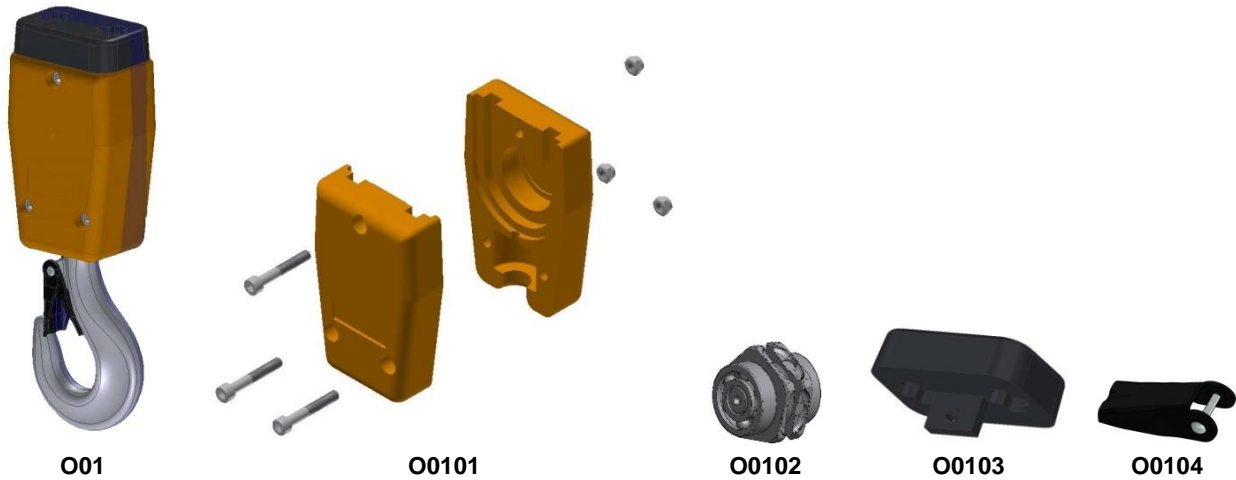

Code	Bezeichnung	Version	Bestellnummer	
<b>O01</b>	Hakenflasche kpl.	4x12	20 2 020 50 000/0	
		5,2x15	20 2 030 50 000/0	
		7,2x21	2000 kg	20 2 070 50 000/1
			2500 kg	20 2 070 56 000/1
		9x27		20 2 090 50 000/1
<b>O0101</b>	Gehäuse für Hakenflasche kpl.	11,3x31	20 2 110 50 000/0	
		4x12, 5,2x15	20 9 020 50 001/0	
		7,2x21	20 9 070 50 001/2	
		9x27	20 9 090 50 001/1	
<b>O0102</b>	Kettennuss	11,3x31	20 9 110 50 001/0	
		4x12	20 2 020 50 005/0	
		5,2x15	20 2 030 50 005/0	
		7,2x21	2000 kg	20 2 070 50 005/0
			2500 kg	20 2 070 56 005/0
<b>O0103</b>	Gummipuffer	9x27	20 2 090 50 005/0	
		11,3x31	20 2 110 50 005/0	
		4x12, 5,2x15	20 0 020 50 014/0	
		7,2x21	20 0 070 50 014/0	
			ab ca. 05/2011	20 0 070 50 014/2
<b>O0104</b>	Hakensicherung kpl.	9x27	20 0 090 50 014/1	
		11,3x31	20 0 110 50 014/0	
		4x12, 5,2x15	20 9 020 50 003/0	
		7,2x21	20 9 070 50 003/1	
	9x27	20 9 090 50 003/0		
	11,3x31	20 9 110 50 003/1		

## P - Hakengeschirr

### Bauform STAR 02./.. – 05./..



**P01**



**P0101**



**P0102**

Code	Bezeichnung	Version	Bestellnummer
<b>P01</b>	Hakengeschirr kpl. Skeletto	4x12	15 2 020 50 000/0
		5,2x15	15 2 030 50 000/0
<b>P0101</b>	Gummipuffer		35 S0015 00300
<b>P0102</b>	Hakensicherung kpl	Skeletto R 012	15 9 020 50 003/1 10/2015
		RSN 012	15 9 020 50 003/0

### Bauform STAR 07./..



**P01**



**P0101**



**P0102**

Code	Bezeichnung	Version	Bestellnummer
<b>P01</b>	Hakengeschirr kpl.	7,2x21	15 2 070 50 000/3
<b>P0101</b>	Gummipuffer		35 00015 00700
<b>P0102</b>	Hakensicherung kpl		20 9 020 50 003/0

## Bauform STAR 09./..



P01



P0101



P0102

Code	Bezeichnung	Version	Bestellnummer
P01	Hakengeschirr kpl.	9x27	15 2 090 50 000/1
P0101	Gummipuffer		35 S0015 00901
P0102	Hakensicherung kpl		20 9 070 50 003/1

## Bauform STAR 11./..

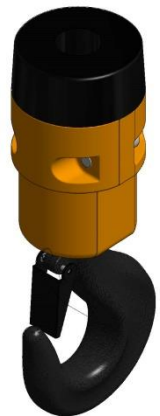

P01

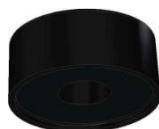

P0101



P0102

Code	Bezeichnung	Version	Bestellnummer
P01	Hakengeschirr kpl.	11,3x31	15 2 110 50 000/0
P0101	Gummipuffer		35 00015 01100
P0102	Hakensicherung kpl		20 9 090 50 003/0



## Q – Hubbegrenzer

### Bauform STAR 02./.. – 05./..



Q01



Q0101

Code	Bezeichnung	Version	Bestellnummer
Q01	Hubbegrenzer kpl.	4x12	03 2 020 50 010/1
		5,2x15	03 2 030 50 010/1
Q0101	Gummipuffer		35 S0001 00300

### Bauform STAR 07./..



Q01



Q0101

Code	Bezeichnung	Version	Bestellnummer
Q01	Hubbegrenzer kpl.	7,2x21	03 2 070 50 010/0
Q0101	Gummipuffer		35 S0001 00700

### Bauform STAR 09./..



Q01



Q0101

Code	Bezeichnung	Version	Bestellnummer
Q01	Hubbegrenzer kpl.	9x27	03 2 090 50 010/0
Q0101	Gummipuffer		35 S0015 00901

### Bauform STAR 11./..



Q01



Q0101

Code	Bezeichnung	Version	Bestellnummer
Q01	Hubbegrenzer kpl.	11,3x31	03 2 110 50 010/1
Q0101	Gummipuffer		35 S0015 00901

## R - Kettenspeicher

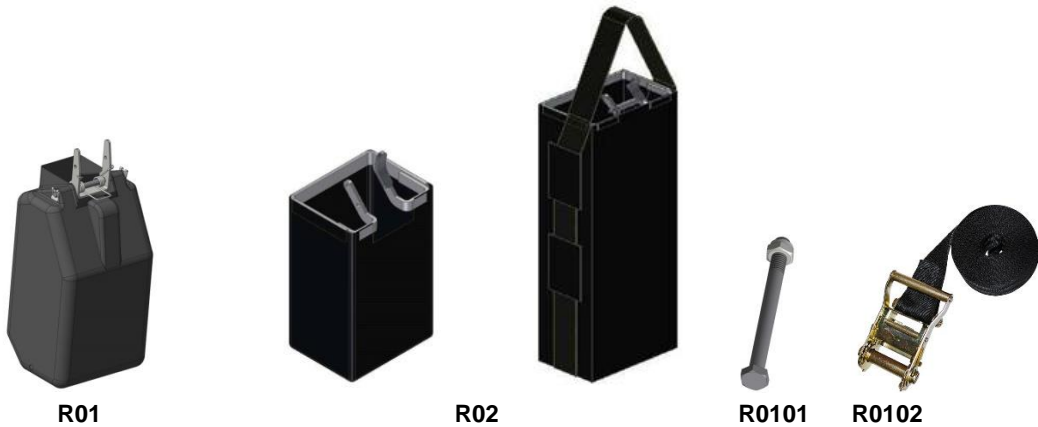

Code	Bezeichnung	Version	Kette/Meter		Bestellnummer	
<b>R01</b>	Kettenspeicher Plastik	STAR 02../.., 03../..	4/12	5/8	30 2 020 50 000/1	
			4/16	5/10	30 2 030 50 000/1	
		STAR 05../.., 07../..	5/8	7/5	30 2 050 51 000/1	
			5/10	7/8	30 2 050 50 000/1	
<b>R02</b>	Kettenspeicher Textil	STAR 02../.., 03../..	4/10	5/8	30 2 030 50 000/2	
			4/20	5/18	30 2 030 51 000/0	
			4/30		30 2 030 52 000/0	
			4/40	5/25	30 2 030 53 000/0	
			4/50	5/40	30 2 030 54 000/0	
			4/80	5/60	30 2 030 56 000/0	
				5/70	30 2 030 57 000/0	
				5/90	30 2 030 58 000/0	
			STAR 05../.., 07../..	5/8		30 2 050 50 000/0
				5/18	7/8	30 2 050 51 000/0
		5/25		7/18	30 2 050 52 000/0	
		5/40		7/24	30 2 050 53 000/0	
		5/50			30 2 050 54 000/0	
		5/60		7/30	30 2 050 55 000/0	
		5/70			30 2 050 56 000/0	
		5/90			30 2 050 58 000/0	
				7/40	30 2 070 57 000/0	
				7/50	30 2 070 59 000/0	
			7/60	30 2 070 60 000/0		
		STAR 09../.., 11../..	9/10	11/6	30 2 110 50 000/0	
9/18	11/12		30 2 110 51 000/0			
9/30	11/20		30 2 110 54 000/0			
9/40	11/25		30 2 110 56 000/0			
9/50	11/30		30 2 110 57 000/0			
9/60	11/40		30 2 110 58 000/0			
	9/75	11/50	30 2 110 59 000/0			
<b>R0101</b>	Befestigungsschraube	STAR 02../.., 03../..			30 9 020 50 100/0	
		STAR 05../.., 07../..			30 9 050 50 100/0	
		STAR 09../.., 11../..			30 9 110 50 100/0	
<b>R0102</b>	Set – Entlastungsgurt für Kettenspeicher	für Kettengewichte über 25 kg			30 9 030 54 012/0	

## Kettenspeicher – Flip Bag

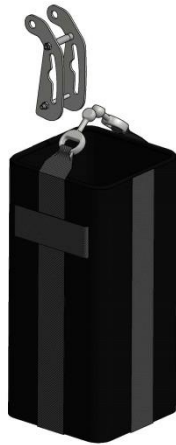

R03



R0301



R0302

### Bauform STAR 02../.., 03../..

Code	Bezeichnung	Version	Bestellnummer	Bestellnummer
		Kette/Meter	komplett (R03)	einzel (R0301)
R03 /	Kettenspeicher Flip Bag	4/12 5/8	30 2 020 50 230/0	30 2 160 230/0
R0301		4/20 5/18	30 2 020 50 300/0	30 2 160 300/0
		4/40 5/25	30 2 020 50 400/0	30 2 160 400/0
		4/50 5/40	30 2 020 50 500/0	30 2 160 500/0
		4/80 5/60	30 2 020 50 600/0	30 2 160 600/0
		4/100 5/75	30 2 020 50 650/0	30 2 160 650/0
			5/90	30 2 020 50 700/0
R0302	Halteset			30 2 020 50 002/0

### Bauform STAR 05../..

Code	Bezeichnung	Version	Bestellnummer	Bestellnummer
		Kette/Meter	komplett (R03)	einzel (R0301)
R03 /	Kettenspeicher Flip Bag	5/8	30 2 050 50 230/0	30 2 180 230/0
R0301		5/18	30 2 050 50 300/0	30 2 180 300/0
		5/25	30 2 050 50 400/0	30 2 180 400/0
		5/40	30 2 050 50 500/0	30 2 180 500/0
		5/60	30 2 050 50 600/0	30 2 180 600/0
		5/75	30 2 050 50 650/0	30 2 180 650/0
		5/90	30 2 050 50 700/0	30 2 180 700/0
		5/100	30 2 050 50 800/0	30 2 180 800/0
R0302	Halteset			30 2 050 50 002/0

## Bauform STAR 07../..

Code	Bezeichnung	Version Kette/Meter	Bestellnummer komplett (R03)	Bestellnummer einzeln (R0301)
R03 /	Kettenspeicher Flip Bag	7/5	30 2 070 50 230/0	30 2 180 230/0
R0301		7/8	30 2 070 50 300/0	30 2 180 300/0
		7/18	30 2 070 50 400/0	30 2 180 400/0
		7/24	30 2 070 50 500/0	30 2 180 500/0
		7/30	30 2 070 50 600/0	30 2 180 600/0
		7/40	30 2 070 50 650/0	30 2 180 650/0
		7/50	30 2 070 50 700/0	30 2 180 700/0
		7/60	30 2 070 50 800/0	30 2 180 800/0
		7/70	30 2 070 50 900/0	30 2 180 900/0
R0302	Halteset			30 2 070 50 002/0

## Bauform STAR 09../..

Code	Bezeichnung	Version Kette/Meter	Bestellnummer komplett (R03)	Bestellnummer einzeln (R0301)
R03 /	Kettenspeicher Flip Bag	9/10	30 2 090 50 350/0	30 2 230 350/0
R0301		9/18	30 2 090 50 480/0	30 2 230 480/0
		9/30	30 2 090 50 600/0	30 2 230 600/0
		9/40	30 2 090 50 700/0	30 2 230 700/0
R0302	Halteset			30 2 090 50 002/0

## Bauform STAR 11../..

Code	Bezeichnung	Version Kette/Meter	Bestellnummer komplett (R03)	Bestellnummer einzeln (R0301)
R03 /	Kettenspeicher Flip Bag	11/6	30 2 110 50 350/0	30 2 230 350/0
R0301		11/12	30 2 110 50 480/0	30 2 230 480/0
		11/20	30 2 110 50 600/0	30 2 230 600/0
		11/25	30 2 110 50 700/0	30 2 230 700/0
		11/30	30 2 110 50 800/0	30 2 230 800/0
R0302	Halteset			30 2 110 50 002/0

**Bestellformular Ersatzteile**

Kunden-Nr. \_\_\_\_\_  
 Anschrift: \_\_\_\_\_  
 \_\_\_\_\_  
 \_\_\_\_\_  
 \_\_\_\_\_  
 \_\_\_\_\_  
 \_\_\_\_\_  
 \_\_\_\_\_  
 \_\_\_\_\_

**LIFTKET Hoffmann GmbH**  
 Dresdener Straße 64-68  
 04808 Wurzen / Germany



+49-3425-89 24-0  
 +49-3425-89 24-99  
 sales@liftket.de  
 www.liftket.de

**Elektrokettenzug** Typ: \_\_\_\_\_ Spannung: \_\_\_\_\_ V \_\_\_\_\_ Hz \_\_\_\_\_ ph  
 Fabrik-Nr.: \_\_\_\_\_ Steuerung: \_\_\_\_\_ V

Art. Nr.	Bezeichnung	Version	Bestell-Nr.	Stück / Meter

\_\_\_\_\_  
 Ort / Datum

\_\_\_\_\_  
 Unterschrift

\_\_\_\_\_  
 Stempel

Mit diesem Druck verlieren alle vorherigen Ausgaben ihre Gültigkeit!  
Änderungen vorbehalten